

# **Progression in Science, Technology and Smart Computing**



**~ Executive Editor ~  
Dr. Bhaskar V. Tamhankar**

**~ Editor ~  
Dr. Neha Joshi**

**PRARUP PUBLICATIONS**

**ISBN – 978-81-948061-2-7**

**PROGRESSION  
IN  
SCIENCE, TECHNOLOGY  
AND  
SMART COMPUTING**

**Executive Editor**

**Dr. Bhaskar V. Tamhankar**

**Editors**

**Dr. Neha Joshi**

**Dr. Suresh Kumbhar**

**Dr. Narsing Padal**

**Shri. Amar Mane**

**Shri. Uttam Harale**

**Miss. Smruti Kulkarni**

**ISBN – 978-81-948061-2-7**

**PROGRESSION IN SCIENCE, TECHNOLOGY AND  
SMART COMPUTING**

**1<sup>st</sup> Edition 2021**

**Executive Editor:**

**Dr. Bhaskar V. Tamhankar**

**Principal,**

**Willingdon College, Sangli. (M.S.)**

**Publisher:**

***Prarup Publications***

***Kolhapur, Maharashtra.***

**© Editors**

No part of this book may be reproduced or transmitted in any form or by any means, electronic or mechanical including photocopying or by any information storage and retrieval system without permission in writing from the authors or publishers.

**ISBN 978-81-948061-2-7**

**Typeset and Printing**

***Mauli Computers & Printers, Kolhapur***

<b>Sr. No.</b>	<b>Name of Authors</b>	<b>Title of Paper</b>	<b>Page No.</b>
26	Hemant K Upadhyay, Tina	Analysis Of Issues And Challenges Of Online Teaching Using Fuzzy AHP Approach	184 – 191
27	Dr. Prakash Rajaram Chavan	Selection Of Most Informative Maintenance Approach By Using Fuzzy Multiple Criteria Decision Making Method	192 – 199
28	Jyoti Sabarad, Smita Kore, Najmin Mursal, Ashwini Patil, Neha Joshi	A Novel Approach of “5G Enabled IoT”: A Review	200 – 209
29	Madhavi C. Bhosale, Dr. N.M.Kulkarni, Dr.A.D.Shaligram, Sharad Pustake	Comparative Study of RF Attenuation in Open Air with Closed Chamber	210 – 216
30	Uttam Harale, Jyoti Sabrad, Najmin Mursal, Ashwini Patil, Neha Joshi	Development of an Embedded System for Pesticide Residue Detection of Fruits and Vegetables	217 – 222
31	Ashwini Patil, Neha Joshi, Jyoti Sabarad, Najmin Mursal, Suresh Kumbhar	WSN Based Smart Industrial Pollution Monitoring System	223 – 228
32	Satyajit Ramesh Potdar	Modeling, Simulation and Validation of Greenhouse Microclimate	229 – 239
33	Poonam S. Jadhav, R. R. Mudholkar	FPGA Implementation of Fuzzy Logic Controller	240 – 245
34	K. G. Kharade, S. V. Katkar, S. K. Kharade, M. S. Sawant, R. K. Kamat	Review of Home Automation Strategies Analysis using Sensors	246 – 251
35	Sandip M. Dhavale, Nitin M. Kulkarni, Arvind D. Shaligram	A Comprehensive and Systematic Study of Energy Harvesting for Wearable Electronics	252 – 257
36	Asif Jamadar, Nishad Kumbhare, U. R. Harale, S. R. Kumbhar	Future of 7G Wireless Communication Technology and Evaluation	258 - 264
37	P.B.Sakhare, P.B.Dahikar	A Review on Internet of Things Pioneer for Recent COVID -19 and Post Pandemics	265 - 271
38	V. K. Lambe, G. M. Galgale, R. M. Chavan, J. V. Sabarad	IoT Based Home Automation System	272 – 278
39	Mrs. Akshata A. Nayak	Prognosis of Mental Health Disorder Among Population During Pandemic	279 - 286

---

## **FPGA Implementation of Fuzzy Logic Controller**

---

**Poonam S. Jadhav**

*Department of Electronics,  
Shivaji University, Kolhapur  
Maharashtra, India-416004*

**R. R. Mudholkar**

*Department of Electronics,  
Shivaji University, Kolhapur  
Maharashtra, India-416004*

---

**ABSTRACT-** This paper describes FPGA realization of Fuzzy Logic Controller (FLC) using hardware software Co-design methodology. In industrial application fuzzy logic controller is emerged as most promising method to improve the industrial control. The majority of Fuzzy Logic based real time operations require interfacing with high speed constraints. It leads to the need of finding efficient way to hardware implementation. FPGA becomes successful tool for developing the systems that requires a real time operation. It provides hardware rapidity and software flexibility.

**Keywords-** *Fuzzy Logic, FPGA, Co-design.*

### **INTRODUCTION:**

Fuzzy logic control handle complex problem with ease. Fuzzy Logic can be customized and attuned effortlessly to get better or significantly alter system performance, because the Fuzzy Logic Controllers (FLC) processes user-defined rules ruling the target control system. Fuzzy systems are signifying good assurance in consumer products, industrial, commercial and decision support systems. Fuzzy Logic makes use of linguistic depictions to relate the input data with the output action. It has been implemented by various technologies such as digital and analog by using full custom or semi-custom techniques [1]. The reconfigurable FPGA offers hardware/software co-design. This methodology improves significantly the system performance by providing the less time delay among the simulation and response [2]. The fuzzy systems with dynamic reconfiguration, implemented with an FPGA. This co-evolutionary cooperation is used to increase the computing speed of the system [3].

### **IMPLEMENTATION OF FTC IN FPGA:**

The hardware-software codesign approach on FPGA board can be applied for FLC implementation. The Fig.1. presents the design flow of the system.

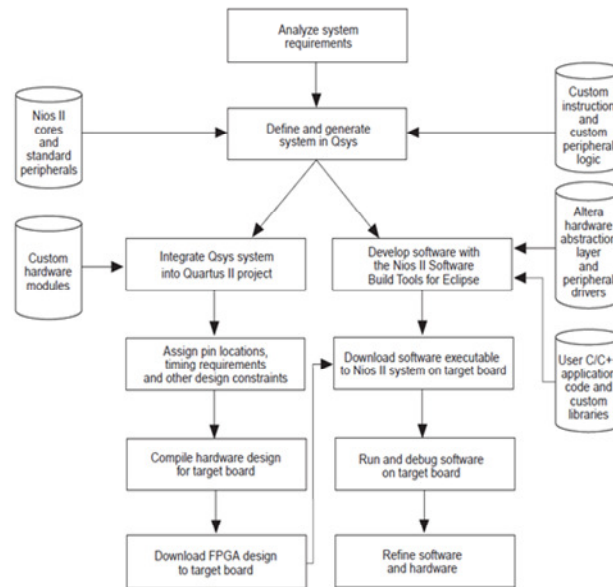

Fig. 1 The Development Flow of Co-design [4]

The development starts with analyzing and selecting the system component as per the system requirement. After that system integration tool Qsys used to specify Nios II processor core, memory and the other components. The hardware system is realized using SOPC builder tool, Qsys in combination with Quartus prime Edition 15.1. Qsys sanctions engendering a system predicated on Nios II.

Integrating Qsys system into Quartus II project, implements hardware modules into the FPGA design. Here pin locations, timing requirements are assigned and other design constraints are applied. Then the hardware design compiled for target board. After that the C application code is developed by using Software Build Tool (SBT). The low level hardware details can be written in Nios II programs with the drivers of component and HAL (hardware abstraction layer) provided by Altera. Along with application code user can design and reprocess custom libraries in Nios II SBT

In order to build a new application project based on C the SBT makes use of the hardware details containing `‘.sopcinfo’` file. Previous to running the application FPGA board the system needs the `‘.sof’` file. Refining hardware and software facility allows user to get better the software algorithm or can return to the hardware design steps to add acceleration logic.

### **FUZZY LOGIC CONTROLLER DESIGN AND IMPLEMENTATION:**

The FLC designing involves fuzzification, inference engine, rule base, defuzzification and data pre and post processing. The software development task has been performed for Nios Processor system by using Nios II-SBT. The SBT is used to write C application code.

A Nios II C application project is created by utilizing the *.sopcinfo* file and *.sof* file. The *.sopcinfo file* is required for getting hardware information of the system and *.sof* file is required to execute the program on the FPGA device.

**A. Fuzzification Module** - Inputs to the FLC are “Error” and “Change-in-Error”. In the present controller triangular and trapezoidal membership functions (MF’s) are used. The values of fuzzy variables are presented in linguistic terms. The linguistic variables for inputs are displayed in Table1.

Table 1: Input Linguistic Variables

Sr. No	Input Variable Name	Crisp Input Range of “Error”	Crisp Input Range of “Change-in-Error (CE)”
01	NM	[-6 -6 -4.6 -2.4]	[-5 -5 -2.5]
02	NS	[-3.5 -2.024 0]	[-3 -1.6 0]
03	Z	[-0.489 0 0.437]	[-0.5 0 0.5]
04	PS	[0 1.45 2.95]	[0 1.6 3]
05	PM	[1.9 3.76 6 6]	[2.5 5 5]

Fig. 2 and Fig. 3 displays membership functions for input variables “Error” and “Change-in-error”.

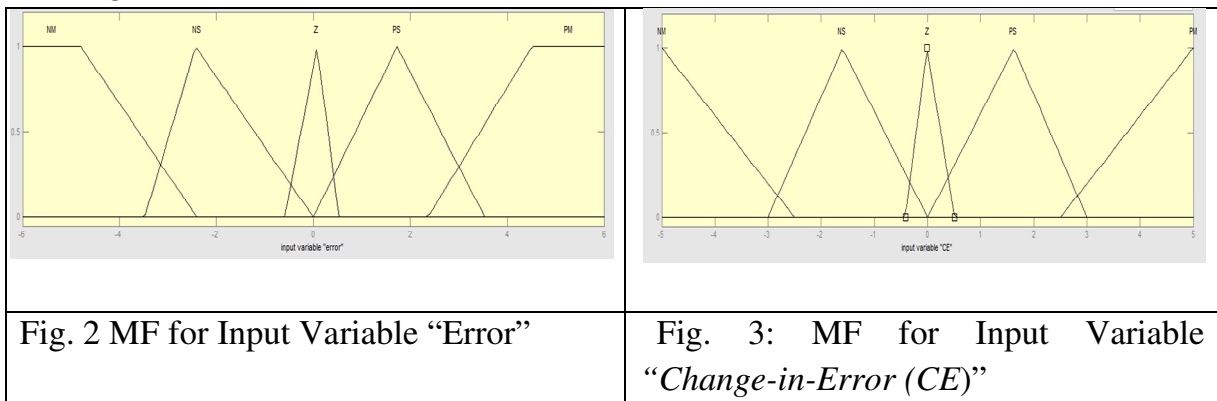

The input variables “Error” and “Change-in-Error” have five membership functions as Negative Medium (NM), Negative Small(NS),Zero(Z),Positive Small(PS), and Positive Medium(PM). A coding of linguistic variables is necessary to include the linguistic variables into the FPGA.

**B. Fuzzy MF’s for Output**

The output variables expressed linguistically are applied to the actuators to control. The linguistic variables for output are displayed in Table 2. Fig. 4 presents membership function for output variable control.

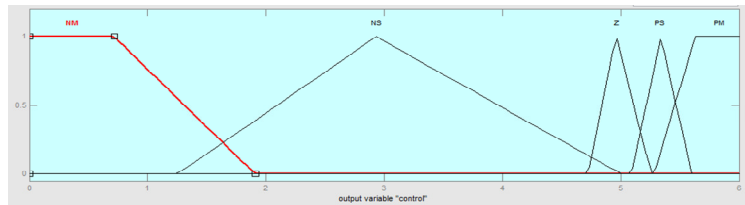

Fig. 4 MF for Output Variable “Control”

Table 2: Output Linguistic Variables

Sr. No	Input Variable Name	Crisp Output Range of “Control”
01	NM	[0 0 0.7 1.9]
02	NS	[1.25 3 5]
03	Z	[4.7 5 5.26]
04	PS	[5 5.34 5.6]
05	PM	[5.28 5.63 6 6]

```
#include "stdio.h"
#define MAXNAME 10 /* max number of characters in names */
#define UPPER_LIMIT 255 /* max number assigned as degree of membership */
#define MIN_TEMP 25
#define MAX_TEMP 100
#define System_Inputs 10
#define System_Outputs 10
#define MIN MIN_TEMP
#define MAX MAX_TEMP
#define RATIO 100/(MAX-MIN)
signed int NM[] ={-50,-50, -35, -20,-4,-4,-3,-2,0,1,1 };
signed int NS[] ={-40,-20, 0, -3,-1.5,0,1,2,3 };
signed int Z[] ={-10,0, 10, -1,0,1,2.5,3,3.5 };
signed int PS[] ={0,20, 40, 0,1.5,3,3,4,5 };
signed int PM[] ={20,35,50,50,2,3,4,4,4,5,6,6};
```

Fig. 5 C code for the input and output variables

The C code for the implementation of fuzzy membership functions has been displayed in Fig. 5.

### C. Inference Module

A FIS processes input data and evaluates the proposed action in terms of their agreement with the knowledge base. An important task in an inference engine is to finding the matching degree among the fuzzified input MF and the antecedent MF [5]. The matching degree can be obtained from max-min operation. The C code in Fig. 6 is applied for the FIS in Nios- II Eclipse SBT.

```
struct rule_element_type {
int *value; /* pointer to antecedent/output strength value */
struct rule_element_type *next; /* next antecedent/output element in rule */
};
struct rule_type{
struct rule_element_type *if_side; /* list of antecedents in rule */
struct rule_element_type *then_side; /* list of outputs in rule */
struct rule_type *next; /* next rule in rule base */
};
struct rule_type *Rule_Base;
```

Fig. 6 C code for Fuzzy Inference Module



**D. Knowledge Representation and Rule Block**

Knowledge base provides the necessary information about the rules and data handling in fuzzy logic controller [6]. The logical rule base indicates the correlation input and output element. Once the current values of the inputs are fuzzified, the FLC starts to make decisions to perform the required operation. The rule consists of “IF-THEN” statement. If part indicates the condition for which it is designed and then part presents reaction of the fuzzy system in that situation. The fuzzy rules are presented in Table 3. It consists of 25 rules. The all 25 rules are executed. For example If the error is Negative Medium (NM) and Change-in-Error (CE) is Negative Medium (NM) then control output is Positive Medium (PM).

Table 3: Fuzzy Rules

Control		Change-in-Error (CE)				
		NM	NS	Z	PS	PM
Error (E)	NM	PM	PM	PM	PS	Z
	NS	PM	PM	PS	Z	NS
	Z	PM	PS	Z	NS	NM
	PS	PS	Z	NS	NM	NM
	PM	Z	NS	NM	NM	NM

The following C code (Fig.7) is applied to implement the fuzzy rules in Nios- II Eclipse SBT.

```

rule_evaluation ()
{
struct rule_type *rule;
struct rule_element_type *ip;          /* pointer of antecedents (if-parts) */
struct rule_element_type *tp;          /* pointer to consequences (then-parts) */
int strength;                          /* strength of rule currently being evaluated */
for (rule=Rule_Base; rule!= NULL; rule=rule->next)
{
strength = UPPER_LIMIT;                /* max rule strength allowed */
for (ip=rule->if_side; ip != NULL; ip=ip->next) /* process if-side of rule to determine strength */
strength = min(strength,(ip->value)); /* process then-side of rule to apply strength */
for(tp=rule->then_side; tp != NULL; tp=tp->next) *(tp->value) = max (strength,(tp->value));
}
}

```

Fig. 7 C code for Implementation of Fuzzy Rules

**E. Defuzzification Module**

The defuzzification process converts fuzzified value into crisp value to use fuzzy results in control application. The output of defuzzification is a numeric value that decides controls output. The “Centre-of-gravity” (COG) defuzzification technique is applied in the present system. This method is consisting of four steps [7].

```

defuzzification ()
{
struct io_type *so;          /* system output pointer */
struct mf_type *mf;         /* output membership function pointer */
int sum_of_products;        /* sum of products of area & centroid */
int sum_of_areas;          /* sum of shortend trapezoid area */
int area;
int centroid;
/* compute a defuzzified value for each system output */
for (so=System_Outputs; so != NULL; so=so->next){
sum_of_products = 0;
sum_of_areas = 0;
for (mf=so->membership_functions; mf != NULL; mf=mf->next){
area = compute_area_of_trapezoid (mf);
centroid = mf->point1 + (mf->point2 - mf->point1)/2;
sum_of_products += area * centroid;
sum_of_areas += area;
}
so->value = sum_of_products/sum_of_areas; /* weighted average */
}
}

```

Fig. 8: C code for defuzzification

**CONCLUSION:**

The FPGA realization of fuzzy logic controller technique on FPGA has been described. By changing parameter values in code and design constraints one can test for different design circuitry. Implementation of FLC in FPGA provides highest execution speed, less time to market use of suitable software tools, and significant integration density.

**REFERENCES:**

- 1) Kim, D. *An Implementation of Fuzzy Logic Controller on the Reconfigurable FPGA System*, IEEE Transactions on Industrial Electronics, Vol.47 (3), pp:703-715,2000.
- 2) Masmoudi, M. S., Song, I., Karray, F., Masmoudi, M., and Derbel, N. *Hardware/Software Approach for FPGA Implementation of Fuzzy Logic Controller*, International Conference on Design and Test of Integrated Systems in Nanoscale Technology, DTIS 2006, pp:419-423,2006.
- 3) Ramos-Arreguin, J. M., Guillen-Garcia, E., Canchola-Magdaleno, S., Pedraza-Ortega, J. C., Gorrostieta-Hurtado, E., Aceves-Fernández, M. A., and Ramos-Arreguin, C. A. *Fuzzy Logic Hardware Implementation for Pneumatic Control of One DOF Pneumatic Robot*, Mexican International Conference on Artificial Intelligence MICAI 2010, Advances in Soft Computing, pp: 500-511,2010.
- 4) Altera Nios II Hardware Development Tool, Browsed on February 2017 [http://persoetis.ensea.fr/olivier.romain/Teaching\\_2A\\_IUT\\_UCP\\_files/tutorial.pdf](http://persoetis.ensea.fr/olivier.romain/Teaching_2A_IUT_UCP_files/tutorial.pdf)
- 5) Lee, C. C. *Fuzzy Logic in Control Systems: Fuzzy Logic Controller-Part I*, IEEE Transactions on Systems, Man and Cybernetics, Vol:20 (2), pp:404-418,1990.
- 6) Ross, T. J. Membership Functions, Fuzzification and Defuzzification. In: Szczepaniak, P. S., Lisboa, P. J. G., Kacprzyk, J. (eds), *Fuzzy Systems in Medicine. Studies in Fuzziness and Soft Computing*, Physica, Heidelberg. Vol.41, pp:48-77,2000.
- 7) Bouselham, L., Hajji, M., Hajji, B., El Mehdi, A., and Hajji, H. *Hardware Implementation of Fuzzy Logic MPPT Controller on A FPGA Platform*, 3rd International Conference on Renewable and Sustainable Energy Conference, 1-6,2015.

*A Reference Book of*

**RECENT TRENDS IN  
SCIENCE AND TECHNOLOGY**



*Chief Editor*  
**Dr. Siddheshwar D. Jadhav**

Published by Deccan Education Society's Willingdon College, Sangli

*Prarup Publication, Kolhapur*

*A Reference Book of*

Recent Trends in Science and Technology

(ISBN): 978-81-948061-9-6

**1<sup>st</sup> Edition:** 2022

(Publication Year)

**Editor in Chief:** Dr. Siddheshwar Dnyaneshwar Jadhav

M.Sc., Ph.D. Institute of Chemical Technology (Former UDCT), Mumbai.

Associate Professor in Chemistry,

Willingdon College, Sangli, Maharashtra, India- 416 415.

sdjchem@gmail.com

**Published by :** Deccan Education Society's Willingdon College, Sangli.

**Publisher :** Prarup Publications, Kolhapur, Maharashtra, India.

**International Standard Book Number (ISBN):** 978-81-948061-9-6

### 3. Electronics (EL)

Chapter	Title of Paper	Authors	Page Number
EL-01	A Scenario of E-Health in the Cloud Era	Jyoti Sabarad, Neha Joshi	156
EL-02	Automated PCB Manufacturing Workstation	Bhavasr Smita Sandeep, Gaware Aba Santosh	165
EL-03	Design and Simulation of Fuzzy Logic Based Temperature Controller for Machine Tool Spindle	P. S. Jadhav, C. B. Patil, G. B. Jirage, R. R. Mudholkar	171
EL-04	FEM Analysis of CMOS Compatible SAW Resonator For 2.45 GHz ISM Band Wireless Application	Pravin R. Bagade, Abhijit J. Pawar, Rajanish R. Kamat, Santosh A. Shinde	180

---

## EL-03. Design and Simulation of Fuzzy Logic Based Temperature Controller for Machine Tool Spindle

P. S. Jadhav<sup>a</sup>, C. B. Patil<sup>a</sup>, G. B. Jirage<sup>a</sup>, R. R. Mudholkar<sup>b</sup>

<sup>a</sup> Department of Electronics, Vivekanand College, Kolhapur (Autonomous), Maharashtra.

<sup>b</sup> Department of Electronics, Shivaji University, Kolhapur, Maharashtra.

\*Corresponding author E-mail : psj.eln@gmail.com

### Abstract:

Fuzzy logic controller has been extensively used for control applications in the industrial and commercial world. The recent tendency in manufacturing industry is demanding high spindle speeds and precision machining to improve productivity and product quality. In this paper a fuzzy logic temperature controller has been designed to control temperature of machine tool Spindle. The temperature of spindle has been controlled with the use of thermoelectric cooler. Mathematical model of a system has been obtained in the form of transfer function. The fuzzy logic controller model has been simulated in Matlab Software.

**Keywords:** Fuzzy Logic Controller (FLC), spindle, Thermoelectric cooler.

### 1. Introduction:

With the escalating industrial requirement of higher productivity and increased accuracy, machine tools with high precision machining capability are required. The spindle dominates the machining precision and productivity. Spindle is the major internal heat source in machining operations. The spindle would generate large amount of heat when it is running at high speed. The heat flow generated due to internal heat source results in thermal deformation of each component. The complex thermal behavior is the predominant factor for determining the performance of machine tool. The accuracy can be increased by reducing or compensating the machining error [1-4].

Kuo et al. implemented analytical modeling for temperature control in surface grinding [5]. Analytical modeling offers high precision in the estimation of thermal deformation, but this model takes large time in the development [6]. Finite Element Method and Finite Difference Method can be used for modelling thermal error. It provides accuracy in results but boundary conditions are not considered in heat transfer characteristics. It takes large time in development [7]. P. Ramanathan et al. has been developed Fuzzy Logic Controller for temperature regulation

process. He has studied the performance of fuzzy controller and PID controller. It was observed that the Fuzzy Logic Controller is faster than the conventional PID Controller [8].

Since the temperature activity of spindle is nonlinear phenomenon, handling the spindle thermal deformation becomes relatively a complex. Fuzzy logic controller (FLC) can deal with this kind of complex problem exactly. Fuzzy systems are signifying good assurance in consumer products, industrial, commercial and decision support systems. Fuzzy Logic can be customized and attuned effortlessly to get better or significantly alter system performance, because the FLC processes user-defined rules ruling the target control system. The control strategies implemented using classical controllers are expressed in mathematical functions and are fundamentally different from human control. FLC easily handles ambiguity and fuzziness present in the database, and process imprecise information with reasoning [9].

The present paper portrays design and simulation of two inputs–single output (DISO) Fuzzy Logic Based Temperature Controller to maintain the spindle temperature within deformation limit.

## 2. Mathematical Modelling of System:

Transfer Function (TF) has been employed for mathematical modeling of thermal Error. TF includes the excellence of the heat transport ethics. Hence the experimental parameters can be calibrated easily and it is reliable with untested inputs. The mathematical form similar to real time response can be acquired by extrapolating data [10]. Mathematical model contains heating effect of spindle, cooling effect of thermoelectric cooler and thermal deformation of spindle. The thermal deformation error [11] is specified by Eq. (1)

$$G_{Error} = \frac{E_{zheat}}{\Delta T} \quad (1)$$

Similarly the first order transfer function for a spindle temperature is represented as Eq. (2).

$$G(t) = \frac{Spindle\ Temperature}{Time} \quad (2)$$

The transfer function of spindle at 1000 rpm [12] is given by Eq. (3)

$$G(t) = \frac{4.88}{523s + 1} \quad (3)$$

Thermal step response of spindle at a 1000 rpm is displayed in Figure.1.

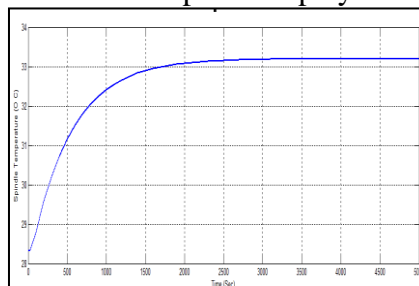

Figure 1. Thermal step response of spindle at 1000 rpm

The cooling system will increase the machining precision with heat confiscation. For cooling jacket cooling or chiller system can be used but it involves complex expensive equipment, chillers required water treatment plant. Thermal errors can be abridged by driving away the heat in the machine tool. Thermoelectric cooling has fewer moving parts, more flexibility and reliability and hence more suitable in high speed machine tool cooling. The thermoelectric air to air cooling method has been projected for the temperature control of machine tool spindle unit [13].

Transfer function for cooling effect of thermoelectric cooler is estimated in Eq. (4).

$$G(S) = \frac{\text{Temperature}}{\text{Current}} = \frac{-2.6}{50s + 1} e^{0s} \quad (4)$$

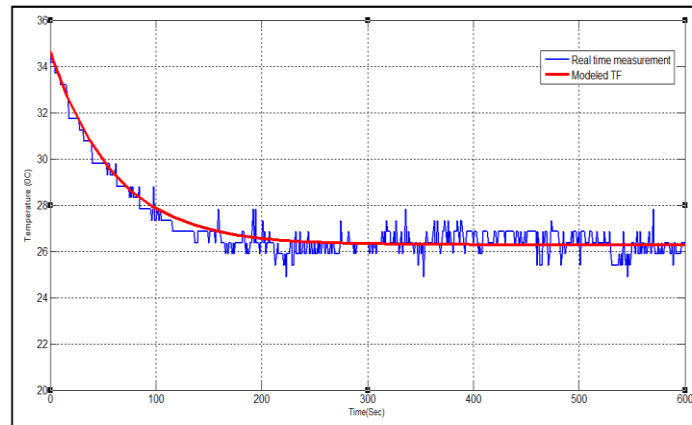

Figure 2. Thermoelectric cooler response

Figure 2 reveals that thermoelectric cooler able to reduce the temperature about by 9°C. The transfer function of spindle system prototype is given in Eq. (5). This equation has been used for simulation.

$$G(t) = \frac{-0.815}{573.1s + 1} \quad (5)$$

### 1. Fuzzy Logic Based Temperature Controller

The Fuzzy Logic based temperature control system for spindle is as in Figure 3. The present control system has a process i.e spindle, Fuzzy Inference System (FIS) with sensor feedback and thermoelectric cooler.



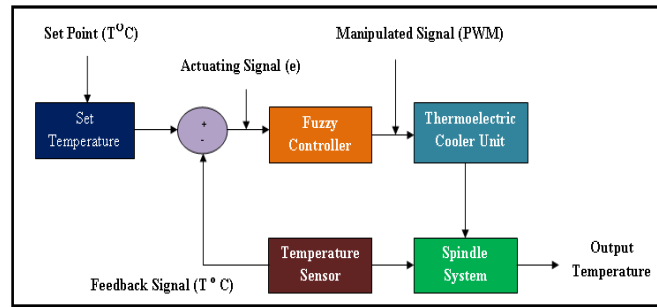

Figure 3. Fuzzy Logic based Temperature Controller

The set point is the reference temperature of the process. The error signal is the variation between the present temperature and standard reference temperature of the process. The Fuzzy controller generates the requisite control signal to control actuators to handle the process. The FIS make a use of fuzzy set for mapping input to the output. FIS includes fuzzy membership functions, operators, and fuzzy rules.

### 3. Design and Matlab simulation of Fuzzy Logic Based Temperature control System:

The Fuzzy Temperature Controller has been designed and simulated using Fuzzy Logic Tool Box and Simulink framework of Matlab [Ver.2015b]. It has two inputs “Error” and “Change-in-Error (CE)” these inputs are processed by Fuzzy Logic Temperature controller and provide the control signal to the thermoelectric cooler to control the temperature of machine tool. Error is the difference between present temperature and set temperature. The change in error is the difference between the present error and previous error. The block diagram of two input and one output Fuzzy Mamdani system has been displayed in 4.

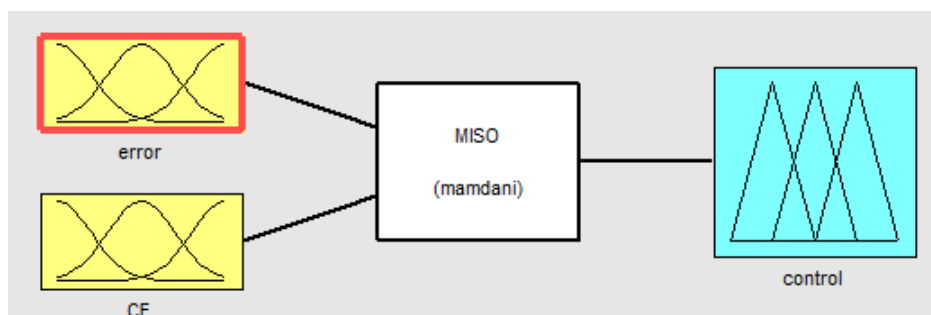

Figure 4. Block diagram of DISO Fuzzy Mamdani System

The input variable “Error” is consisting of five membership functions (MF’s) contains two trapezoidal and three triangular MF’s (Figure 5).

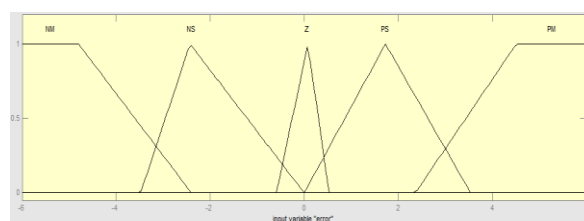

Figure 5. MF for Input Variable “Error”

The second input “Change-in –Error” variable has five triangular membership functions (Figure6).

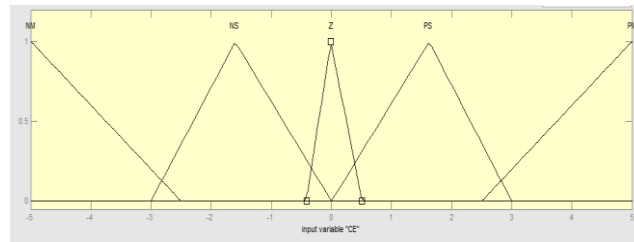

Figure 6. MF for Input Variable “Change-in-Error (CE)”

output variable “Control” consist of two trapezoidal and three triangular MF’s (Figure 7).

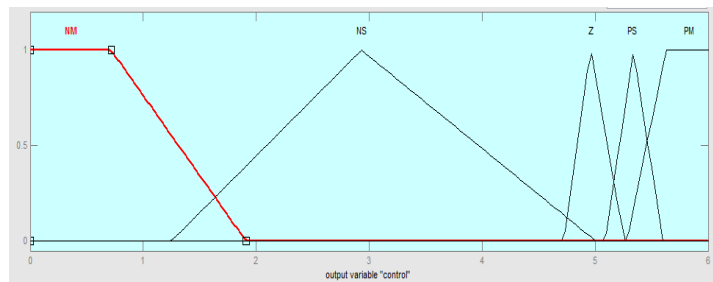

Figure 7. MF for Output Variable “Control”

Input and output linguistic variable range has been displayed in Table 1. The five linguistic variables are NM=Negative Medium, NS= Negative Medium, Z=Zero, PS=Positive Small, PM= Positive Medium.

Table 1. All Input and Output Range of Linguistic Variable

Sr. No	Input Variable Name	Crisp Input Range of “Error”	Crisp Input Range of “Change-in-Error (CE)”	Crisp Output Range of “Control”
01	NM	[-6 -6 -4.6 -2.4]	[-5 -5 -2.5]	[0 0 0.7 1.9]
02	NS	[-3.5 -2.024 0]	[-3 -1.6 0]	[1.25 3 5]
03	Z	[-0.489 0 0.437]	[-0.5 0 0.5]	[4.7 5 5.26]
04	PS	[0 1.45 2.95]	[0 1.6 3]	[5 5.34 5.6]
05	PM	[1.9 3.76 6 6]	[2.5 5 5]	[5.28 5.63 6 6]

In fuzzy logic decision relies on the rules. The rule base is constructed to control the output variable. A fuzzy rule is a IF-THEN rule with condition and conclusion. Fuzzy rules are presented in Table 2. It consists of 25 rules. The all 25 rules are executed. For example if the error is Negative Small (NS) and Change-in-Error (CE) is Negative Medium (NM) then control output is Positive Medium (PM).

Table 2. Control Rules

Control		Change-in-Error (CE)				
		NM	NS	Z	PS	PM
Error (E)	NM	PM	PM	PM	PS	Z
	NS	PM	PM	PS	Z	NS
	Z	PM	PS	Z	NS	NM
	PS	PS	Z	NS	NM	NM
	PM	Z	NS	NM	NM	NM

The Simulink model for Two Input Single Output system (DISO) is given in Figure 8. The Simulink model simulates and analyzes the mathematical modeling of DISO system in the Matlab framework. The FLC has two inputs “Error” and “Change-in-Error”. This Simulink model consists of spindle transfer function, TEC cooler prototype and fuzzy logic controller (FLC). The set temperature is 27°C. The FLC generates control output that drives the TEC used for compensation of spindle temperature.

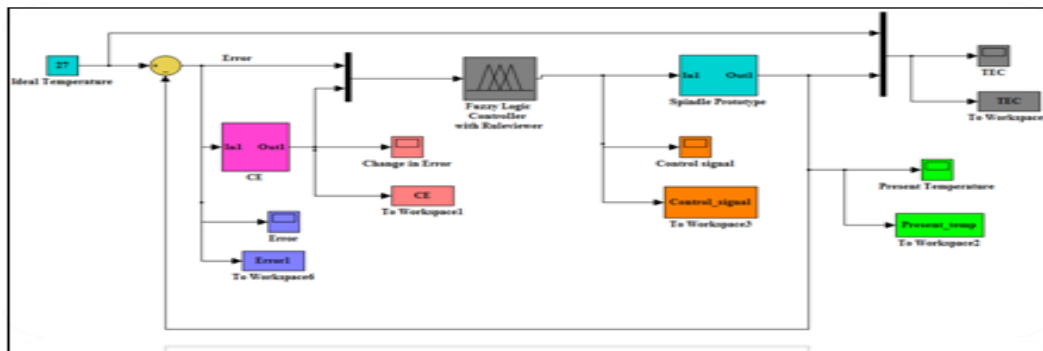

Figure 8. Simulink Model for DISO fuzzy logic controller

#### 4. Simulation Results:

The Matlab simulation of two input-single output (DISO) fuzzy logic system has been carried out to maintain spindle temperature at 27°C. The machining operations are generally executed at ambient temperature. Therefore for the demonstration purpose 27°C is chosen as an Ideal temperature for a spindle system prototype. The result of simulation has been displayed in Figure 9.

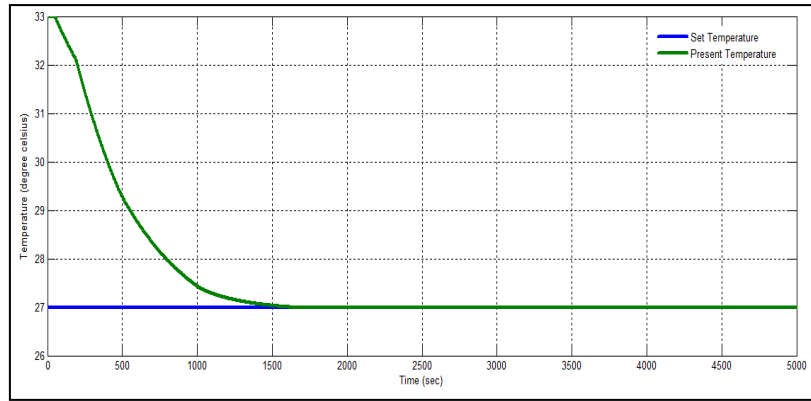

Figure 9. Set point achieved

From the Figure 9, it is observed that the spindle temperature reaches up to  $33^{\circ}\text{C}$  at 1000 rpm. In the present research thermoelectric cooler reduces the temperature by  $6^{\circ}\text{C}$ .

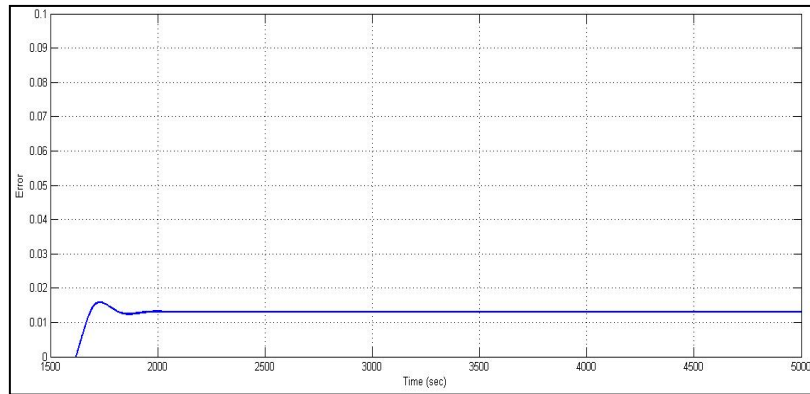

Figure 10. Error Obtained

Figure.10 shows the result of simulation of spindle system prototype. The simulation was performed from 0 to 5000 sec. The “Error” in simulation is  $0.015^{\circ}\text{C}$  that is  $\pm 0.25\%$ . The settling time for the simulation is 2000 sec.

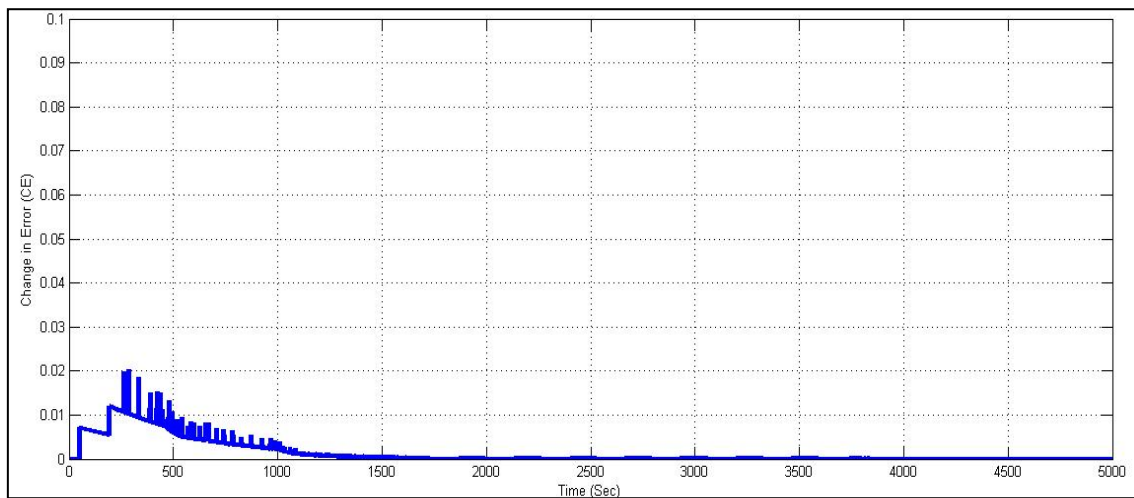

Figure 11. Change in Error (CE)

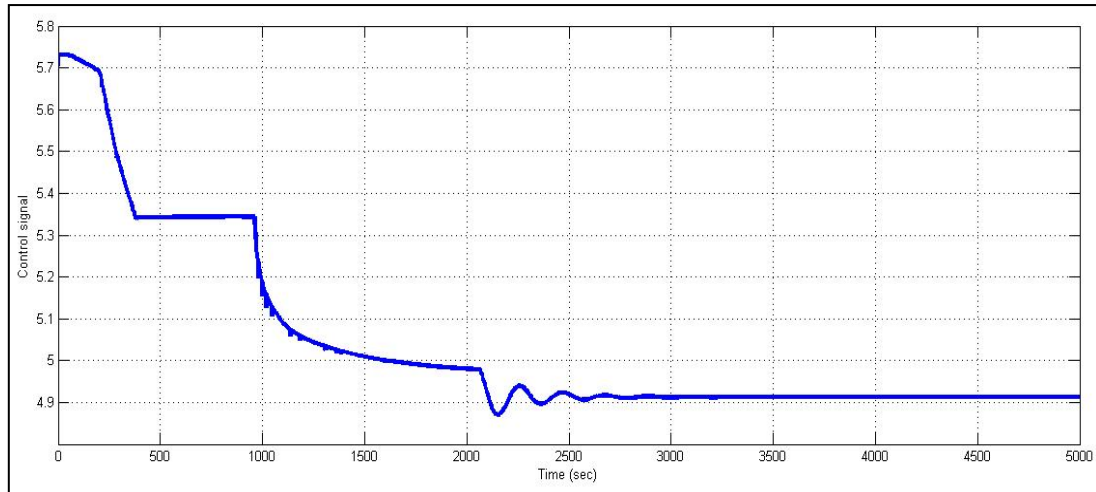

Figure 12. Control Signal

The “change-in-error” (Figure 11) varies continuously between the 0 and 0.02 range. Gradually it settles down to 0 at about 1200 sec. Figure.12 gives an idea about the output control signal generated by FLTC that supplied to the Thermoelectric Cooler to compensate spindle temperature. According to thermal error produced control signal varies to reduce the “Error” and “Change-in-Error” and to settle down the system at the requisite temperature.

## 5. Conclusion:

The Fuzzy Logic based Temperature Controller for spindle of a machine tool has been designed and simulated using Matlab Software successfully. In the simulation result it is found that the system maintains spindle temperature at ambient temperature ( $27^{\circ}\text{C}$ ). This reduces thermal error and increases accuracy in spindle machining operation.

## 6. References:

- [1] Li, Y., and Zhao, W. Axial Thermal Error Compensation Method for the Spindle of a Precision Horizontal Machining Center. *In: Mechatronics and Automation (ICMA), International Conference on, IEEE, 2319-2323(2012).*
- [2] Yashioka, H., Matsumura, S., Hashizume, H., & Shinno, H. Minimizing Thermal Deformation of Aerostatic Spindle System by Temperature Control of Supply Air. *JSME International Journal Series, 49 (2), 606-611(2006)..*
- [3] Haitao, Z., Jianguo, Y., & Jinhua, S., Simulation of Thermal Behavior of a CNC Machine Tool Spindle. *International Journal of a Machine Tools and Manufacture, 47(6), 1003-1010 (2007).*
- [4] Pawel, T., Jedrzejewski, J., & Wojciech, K. Survey of Machine Tool Error Measuring Methods. *Journal of Machine Engineering, 11(4), 7-38(2011).*

- 
- [5] Wen, K., Lin, L., & Fin, J. General Temperature Rise Solution for a Moving Plane Heat Source Problem in Surface Grinding. *International Journal of Advance Manufacturing Technology*.31, 268–277(2006).
- [6] Dementjev, A., Hensel, B., Kabitzsch, K., Kauschinger, B., and Schroeder, S. Virtual Sensor for Calibration of Thermal Models of Machine Tools .*Advances in Artificial Neural Systems, Hindawi Publishing Corporation*m.1-10 (2014).
- [7] Abdulshahed, A., Andrew, M., Longstaff, P., & Fletcher, S. The Application of ANFIS prediction Models for Thermal Error Compensation on CNC machine tools. *Applied Soft Computing*. 27, 158–168(2015).
- [8] P. Ramanathan. Fuzzy Logic Controller for Temperature Regulation Process. *Middle-East Journal of Scientific Research*.20 (11), 1524-1528 (2014).
- [9] Albertos, P., & Sala, A. Fuzzy Logic Controllers. Advantages and Drawbacks, <http://personales.upv.es/asala/publics/papers/C24ALCA98.pdf> Browsed on January 2018.
- [10] Horejs, O., Mares, M., & Hornych, J. A General Approach to Thermal Error Modelling of Machine tools.*Conference on Machines et. Usinage à Grande Vitesse (MUGV), Clermont Ferrand, France*, 1-10,(2014).
- [11] Horejs, O., Mares, M., Kohut, P., Barta, P., & Hornych, J. Compensation of Machine Tool Thermal Errors Based on Transfer Functions, *MM Science Journal*, 162-165(2010).
- [12] Patil Poonam S., Kamat R. K., & Mudholkar R. R.TF Estimation and Thermal Behavioral Analysis of Spindle Cooler System Prototype. *Research Journal of Engineering and Technology*. 9(1)37-44(2018).
- [13] Patil Poonam S. & Mudholkar R. R .Cooling Techniques for a Spindle of Machine Tool. *International Journal of Engineering and Computer Science*, 5(12). 19653-19656(2016).